

DOBRADIÇA 133X

A dobradiça 133X para caneco de 35mm oferece fechamento suave e silencioso, com sistema de clip rápido para instalação prática e amortecedor aprimorado, garantindo maior durabilidade e desempenho superior em diversas aplicações.

● Especificações

Ângulo de abertura em 110°

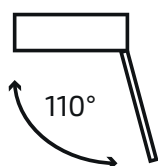

Portas com espessura entre 14 e 26mm

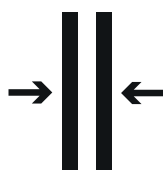

Fácil fixação por clip

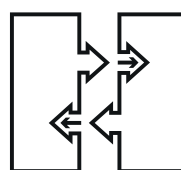

Fechamento amortecido



● Componentes

● 133X Reta

DESCRIÇÃO	PRODUTO
320410064	DOBRADICA 133X RETA AMORT NIQUEL
320410226	DOBRADICA 133X RETA AMORT TITANIO

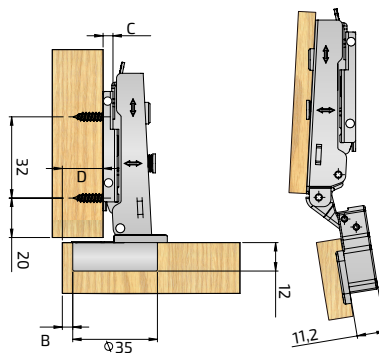

Cálculo para altura do calço



$$C = B + K - D$$

$$K = 10,5\text{mm}$$

● 133X Curva

DESCRIÇÃO	PRODUTO
320411066	DOBRADICA 133X CURVA AMORT NIQUEL
320411221	DOBRADICA 133X CURVA AMORT TITANIO

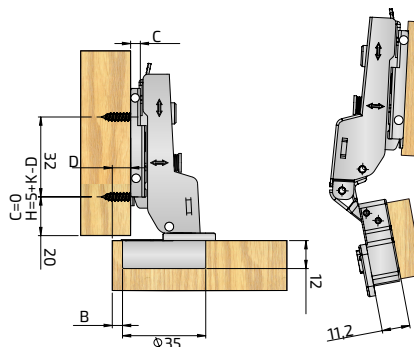

Cálculo para altura do calço



$$C = B + K - D$$

$$K = 2,5\text{mm}$$

● Componentes

● 133X Super Curva

DESCRIÇÃO	PRODUTO
320412061	DOBRADICA 133X SUPER CURVA AMORT NIQUEL
320412223	DOBRADICA 133X SUPER CURVA AMORT TITANIO

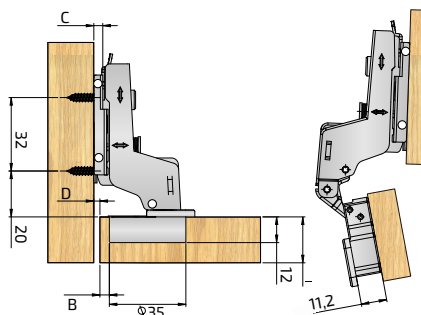

Cálculo para altura do calço



$$C = B + K + D$$

$$K = -6,5\text{mm}$$

● Calço 4 furos

DESCRIÇÃO	PRODUTO
350215062	CALÇO 4 FUROS DOBRADIÇA 132X 0MM
350215224	CALÇO 4 FUROS DOBRADIÇA 132X 0MM TITANIO
350217066	CALÇO 4 FUROS DOBRADIÇA 132X 2MM
350217221	CALÇO 4 FUROS DOBRADIÇA 132X 2MM TITANIO



● Calço Cruz

DESCRIÇÃO	PRODUTO
350210103	CALÇO CRUZ DOBRADIÇA 132X 0MM
350212100	CALÇO CRUZ DOBRADIÇA 132X 2MM
350214060	CALÇO CRUZ DOBRADIÇA 132X 4MM
390010062	CALÇO CRUZ EXPAND DOBRADIÇA 132X 0MM



● Componentes

● Calço com Excêntrica

DESCRIÇÃO	PRODUTO
348600066	CALÇO DOBRADIÇA 132X 0MM COM EXCÊNTRICA
348600221	CALÇO DOBRADIÇA 132X 0MM COM EXCÊNTRICA TITÂNIO
348602063	CALÇO DOBRADIÇA 132X 2MM COM EXCÊNTRICA
348602225	CALÇO DOBRADIÇA 132X 2MM COM EXCÊNTRICA TITÂNIO



● Calço Linear

DESCRIÇÃO	PRODUTO
350810062	CALÇO LINEAR DOBR 133X 0MM C/EXC NIQUEL
350810224	CALÇO LINEAR DOBR 133X 0MM C/EXC TITANIO



● Tampas de acabamento

DESCRIÇÃO	PRODUTO
302131266	TAMPA DOBRADICA 132X RETA
302131224	TAMPA DOBRADICA 132X RETA TITÂNIO
302531106	TAMPA DOBRADICA 132X CURVA E SUPER CURVA
302531224	TAMPA DOBRADICA 132X CURVA E SUPER CURVA TITÂNIO
302132040	TAMPA DOBRADICA 132X PARA CANECO
302132224	TAMPA DOBRADICA 132X PARA CANECO TITÂNIO

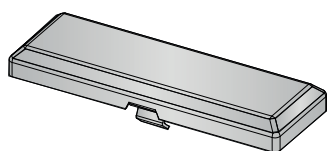

Tampa Retta

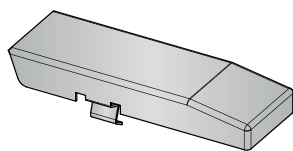

Tampa Curva e Super Curva



Tampa Caneco

Consulte a opção de personalização da sua marca.

- Limitador de abertura em 90°

DESCRIÇÃO	PRODUTO
352600006	REDUTOR DE ANGULO 90 GRAUS 132X

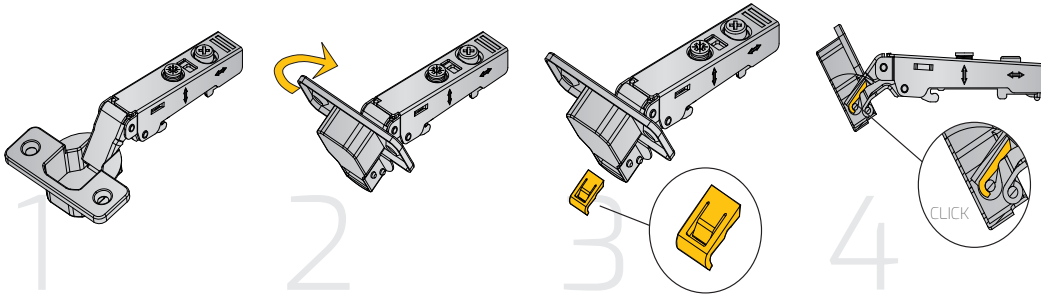
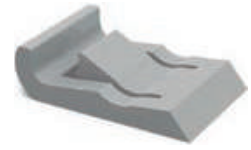

- Dados Técnicos

Deslocamento lateral da porta (F).

mm	Espessura da Porta								
B	16	17	18	19	20	21	22	23	24
3	0,8	1	1,4	1,8	2,2	2,8	3,5	4,3	5,0
4	0,8	1	1,4	1,7	2,1	2,7	3,3	4,3	4,7
5	0,8	1	1,4	1,6	2,0	2,5	3,1	3,7	4,4
6	0,8	1	1,4	1,6	2,0	2,4	2,9	3,5	4,1
7	0,7	0,9	1,2	1,5	1,9	2,3	2,8	3,3	3,8

B = Distância de perfuração do caneco a borda da porta

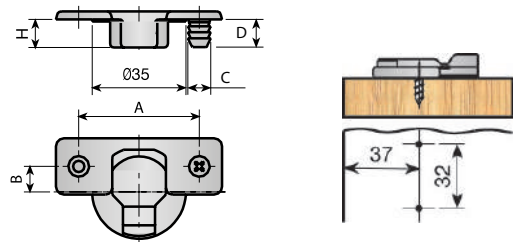

Ajuste lateral de
-2,5mm +2,5mm

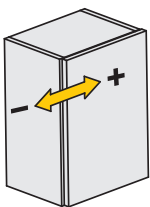

Ajuste fornal de
-2mm +3mm

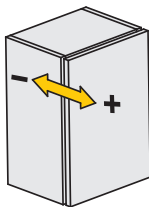

Calço fixo = 2mm
Calço com excêntrica = 1,6mm

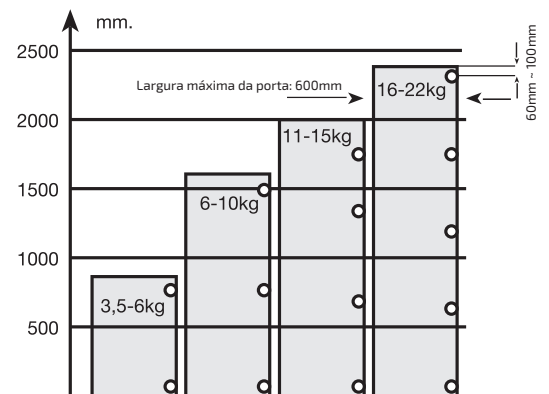
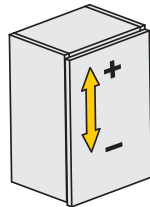

Dobradiças por porta